

Data Sheet | Item Number: 249-117

Screwless end stop; 10 mm wide; for DIN-rail 35 x 15 and 35 x 7.5; gray

<https://www.wago.com/249-117>

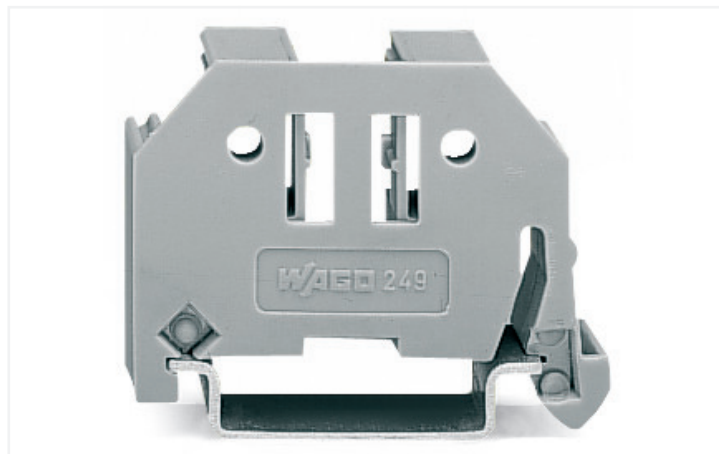
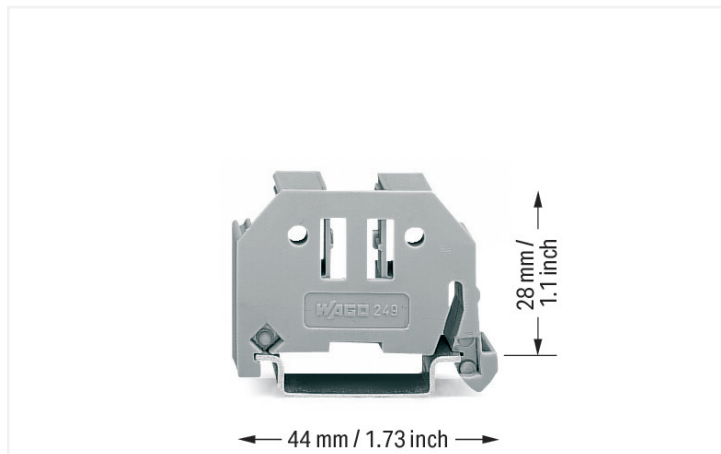

Color: ■ gray

Notes

Note

Snap on – that's it!

Assembling the new WAGO screwless end stop is as simple and quick as snapping a WAGO rail-mount terminal block onto the rail.

Tool free!

A tool-free design allows rail-mount terminal blocks to be safely and economically secured against any movement on all DIN-35 rails per DIN EN 60715 (35 x 7.5 mm; 35 x 15 mm).

Entirely without screws!

The "secret" to a perfect fit lies in the two small clamping plates which keep the end stop in position, even if the rails are mounted vertically.

Simply snap on – that's it!

In addition, costs are significantly reduced when using large numbers of end stops. Additional benefit: Three marker slots for all WAGO rail-mount terminal block markers and one snap-in hole for WAGO adjustable height group marker carriers offer individual marking options.

Technical data

Main product function	Mounting accessories
Mounting type	DIN-35 rail

Physical data

Width	10 mm / 0.394 inches
Height	44 mm / 1.732 inches
Depth	35 mm / 1.378 inches
Depth from upper-edge of DIN-rail	28 mm / 1.102 inches

Material data

Color	gray
Insulation material	Polyamide (PA66)
Flammability class per UL94	V0
Fire load	0.153 MJ
Weight	5.1 g

Commercial data	
Product Group	2 (Terminal Block Accessories)
eCl@ss 10.0	27-14-11-35
eCl@ss 9.0	27-14-11-35
ETIM 8.0	EC001041
ETIM 7.0	EC001041
PU (SPU)	50 (25) pcs
Packaging type	Box
Country of origin	CN
GTIN	4055143314169
Customs tariff number	39269097900

Environmental Product Compliance	
RoHS Compliance Status	Compliant, No Exemption

Downloads

Environmental Product Compliance

Compliance Search	
Environmental Product Compliance 249-117	↓

Documentation

Bid Text			
249-117	19.02.2019	xml 2.66 KB	↓
249-117	31.08.2017	doc 23.50 KB	↓

CAD/CAE-Data

CAD data	
2D/3D Models 249-117	↓











CAE data	
EPLAN Data Portal 249-117	↓
WSCAD Universe 249-117	↓
ZUKEN Portal 249-117	↓

1 Compatible Products



1.1 Optional Accessories

1.1.1 Marking





























1.1.1.1 Group marker carrier

 Item No.: 2009-163 Group marker carrier; gray	 Item No.: 209-140 Group marker carrier; gray	 Item No.: 209-141 Group marker carrier; gray	 Item No.: 209-142 Group marker carrier; gray
 Item No.: 249-105 Group marker carrier; gray	 Item No.: 249-118 Group marker carrier; gray	 Item No.: 249-119 Group marker carrier; gray	 Item No.: 709-118 Group marker carrier; gray
 Item No.: 709-119 Group marker carrier; gray	 Item No.: 209-112 Group marker carrier; white	 Item No.: 249-120 Group marker carrier; white	

1.1.1.2 Label

 Item No.: 210-808 Labels; for Smart Printer; 9.5 x 25 mm; white	 Item No.: 210-708 Labels; for TP printers; 9.5 x 25 mm; white
--	--

1.1.1.3 Marker

 Item No.: 2009-145/000-006 Mini-WSB Inline; for Smart Printer; 1700 pieces on roll; stretchable 5 - 5.2 mm; plain; snap-on type; blue	 Item No.: 2009-145/000-007 Mini-WSB Inline; for Smart Printer; 1700 pieces on roll; stretchable 5 - 5.2 mm; plain; snap-on type; gray	 Item No.: 2009-145/000-023 Mini-WSB Inline; for Smart Printer; 1700 pieces on roll; stretchable 5 - 5.2 mm; plain; snap-on type; green	 Item No.: 2009-145/000-012 Mini-WSB Inline; for Smart Printer; 1700 pieces on roll; stretchable 5 - 5.2 mm; plain; snap-on type; orange
 Item No.: 2009-145/000-005 Mini-WSB Inline; for Smart Printer; 1700 pieces on roll; stretchable 5 - 5.2 mm; plain; snap-on type; red	 Item No.: 2009-145/000-024 Mini-WSB Inline; for Smart Printer; 1700 pieces on roll; stretchable 5 - 5.2 mm; plain; snap-on type; violet	 Item No.: 2009-145 Mini-WSB Inline; for Smart Printer; 1700 pieces on roll; stretchable 5 - 5.2 mm; plain; snap-on type; white	 Item No.: 2009-145/000-002 Mini-WSB Inline; for Smart Printer; 1700 pieces on roll; stretchable 5 - 5.2 mm; plain; snap-on type; yellow
 Item No.: 248-501/000-006 Mini-WSB marking card; as card; not stretchable; plain; snap-on type; blue	 Item No.: 248-501/000-007 Mini-WSB marking card; as card; not stretchable; plain; snap-on type; gray	 Item No.: 248-501/000-023 Mini-WSB marking card; as card; not stretchable; plain; snap-on type; green	 Item No.: 248-501/000-017 Mini-WSB marking card; as card; not stretchable; plain; snap-on type; light green
 Item No.: 248-501/000-012 Mini-WSB marking card; as card; not stretchable; plain; snap-on type; orange	 Item No.: 248-501/000-005 Mini-WSB marking card; as card; not stretchable; plain; snap-on type; red	 Item No.: 248-501/000-024 Mini-WSB marking card; as card; not stretchable; plain; snap-on type; violet	 Item No.: 248-501 Mini-WSB marking card; as card; not stretchable; plain; snap-on type; white
 Item No.: 248-501/000-002 Mini-WSB marking card; as card; not stretchable; plain; snap-on type; yellow	 Item No.: 793-5501/000-006 WMB marking card; as card; for terminal block width 5 - 17.5 mm; stretchable 5 - 5.2 mm; plain; snap-on type; blue	 Item No.: 793-5501/000-007 WMB marking card; as card; for terminal block width 5 - 17.5 mm; stretchable 5 - 5.2 mm; plain; snap-on type; gray	 Item No.: 793-5501/000-023 WMB marking card; as card; for terminal block width 5 - 17.5 mm; stretchable 5 - 5.2 mm; plain; snap-on type; green
 Item No.: 793-5501/000-017 WMB marking card; as card; for terminal block width 5 - 17.5 mm; stretchable 5 - 5.2 mm; plain; snap-on type; light green	 Item No.: 793-5501/000-012 WMB marking card; as card; for terminal block width 5 - 17.5 mm; stretchable 5 - 5.2 mm; plain; snap-on type; orange	 Item No.: 793-5501/000-005 WMB marking card; as card; for terminal block width 5 - 17.5 mm; stretchable 5 - 5.2 mm; plain; snap-on type; red	 Item No.: 793-5501/000-024 WMB marking card; as card; for terminal block width 5 - 17.5 mm; stretchable 5 - 5.2 mm; plain; snap-on type; violet
 Item No.: 793-5501 WMB marking card; as card; for terminal block width 5 - 17.5 mm; stretchable 5 - 5.2 mm; plain; snap-on type; white	 Item No.: 793-5501/000-002 WMB marking card; as card; for terminal block width 5 - 17.5 mm; stretchable 5 - 5.2 mm; plain; snap-on type; yellow	 Item No.: 793-501/000-006 WMB marking card; as card; not stretchable; plain; snap-on type; blue	 Item No.: 793-501/000-007 WMB marking card; as card; not stretchable; plain; snap-on type; gray

1.1.1.3 Marker



Item No.: 793-501/000-023

WMB marking card; as card; not stretchable; plain; snap-on type; green

Item No.: 793-501/000-017

WMB marking card; as card; not stretchable; plain; snap-on type; light green

Item No.: 793-501/000-012

WMB marking card; as card; not stretchable; plain; snap-on type; orange

Item No.: 793-501/000-005

WMB marking card; as card; not stretchable; plain; snap-on type; red



Item No.: 793-501/000-024

WMB marking card; as card; not stretchable; plain; snap-on type; violet

Item No.: 793-501

WMB marking card; as card; not stretchable; plain; snap-on type; white

Item No.: 793-501/000-002

WMB marking card; as card; not stretchable; plain; snap-on type; yellow

Item No.: 2009-115/000-006

WMB-Inline; for Smart Printer; 1500 pieces on roll; stretchable 5 - 5.2 mm; plain; snap-on type; blue



Item No.: 2009-115/000-007

WMB-Inline; for Smart Printer; 1500 pieces on roll; stretchable 5 - 5.2 mm; plain; snap-on type; gray

Item No.: 2009-115/000-023

WMB-Inline; for Smart Printer; 1500 pieces on roll; stretchable 5 - 5.2 mm; plain; snap-on type; green

Item No.: 2009-115/000-017

WMB-Inline; for Smart Printer; 1500 pieces on roll; stretchable 5 - 5.2 mm; plain; snap-on type; light green

Item No.: 2009-115/000-012

WMB-Inline; for Smart Printer; 1500 pieces on roll; stretchable 5 - 5.2 mm; plain; snap-on type; orange



Item No.: 2009-115/000-024

WMB-Inline; for Smart Printer; 1500 pieces on roll; stretchable 5 - 5.2 mm; plain; snap-on type; violet

Item No.: 2009-115

WMB-Inline; for Smart Printer; 1500 pieces on roll; stretchable 5 - 5.2 mm; plain; snap-on type; white

Item No.: 2009-115/000-002

WMB-Inline; for Smart Printer; 1500 pieces on roll; stretchable 5 - 5.2 mm; plain; snap-on type; yellow

Installation Notes

Installation



Snap-on mounting

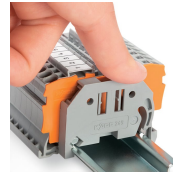
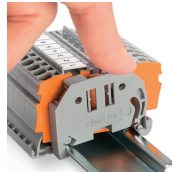

That's it!



Removing an end stop from the DIN-rail.